

Item	Part Number	List Price	Specifications	Dimensions
------	-------------	------------	----------------	------------

DOOR ACCESSORIES

BR7001

S Knocker



- 9BR7001-001** Venetian Bronze 112
- 9BR7001-002** Satin Nickel 150
- 9BR7001-003** Polished Chrome 260
- 9BR7001-004** Polished Brass 003
- 9BR7001-005** Matte Antique Nickel 152
- 9BR7001-006** Matte Brass & Black 049
- 9BR7001-009** Polished Nickel 141

\$55.00

- Solid brass construction
- Available as a complete set with mounting hardware, installation instructions and drill template
- Mounted with through-holes and fits 1-3/4" doors
- Uses 10-24 thru-bolts

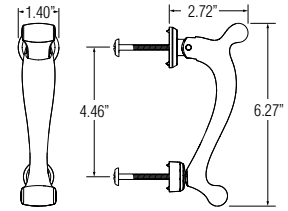

BR7002

Contemporary Knocker



- 9BR7002-001** Venetian Bronze 112
- 9BR7002-002** Satin Nickel 150
- 9BR7002-003** Polished Chrome 260
- 9BR7002-009** Polished Nickel 141
- 9BR7002-010** Satin Black 190

\$55.00

- Solid brass construction
- Available as a complete set with mounting hardware, installation instructions and drill template
- Mounted with through-holes and fits 1-3/4" doors
- Uses 10-24 thru-bolts

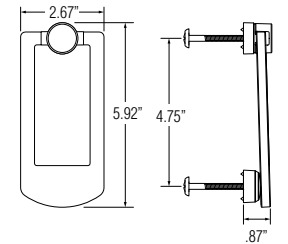

BR7003

Ring Knocker



- 9BR7003-001** Venetian Bronze 112
- 9BR7003-002** Satin Nickel 150
- 9BR7003-003** Polished Chrome 260
- 9BR7003-004** Polished Brass 003
- 9BR7003-005** Matte Antique Nickel 152
- 9BR7003-006** Matte Brass & Black 049
- 9BR7003-007** Dark Bronze 481
- 9BR7003-008** White Bronze 492
- 9BR7003-009** Polished Nickel 141

\$55.00

- Solid brass construction
- Available as a complete set with mounting hardware, installation instructions and drill template
- Mounted with through-holes and fits 1-3/4" doors
- Uses 10-24 thru-bolts

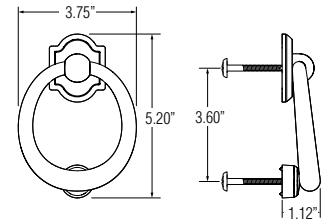

BR7015

Rectangular Bell Button



- 9BR7015-001** Venetian Bronze 112
- 9BR7015-002** Satin Nickel 150
- 9BR7015-003** Polished Chrome 260
- 9BR7015-004** Polished Brass 003
- 9BR7015-005** Matte Antique Nickel 152
- 9BR7015-006** Matte Brass & Black 049
- 9BR7015-010** Satin Black 190

\$34.00

- Brass construction with concealed fasteners
- Illuminated button for easy detection at night
- Recommended for use with up to 24 volt transformers
- Available as a complete set with mounting hardware

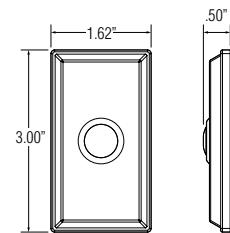

BR7016

Oval Bell Button



- 9BR7016-001** Venetian Bronze 112
- 9BR7016-002** Satin Nickel 150
- 9BR7016-003** Polished Chrome 260
- 9BR7016-004** Polished Brass 003
- 9BR7016-005** Matte Antique Nickel 152
- 9BR7016-006** Matte Brass & Black 049

\$34.00

- Brass construction with concealed fasteners
- Illuminated button for easy detection at night
- Recommended for use with up to 24 volt transformers
- Available as a complete set with mounting hardware

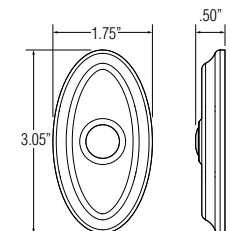

Item	Part Number	List Price	Specifications	Dimensions
------	-------------	------------	----------------	------------

DOOR ACCESSORIES

BR7017

Arch Bell Button



- 9BR7017-001** Venetian Bronze 112
- 9BR7017-002** Satin Nickel 150
- 9BR7017-003** Polished Chrome 260
- 9BR7017-004** Polished Brass 003
- 9BR7017-005** Matte Antique Nickel 152
- 9BR7017-006** Matte Brass & Black 049
- 9BR7017-007** Dark Bronze 481
- 9BR7017-008** White Bronze 492

\$34.00

- Brass construction with concealed fasteners
- Illuminated button for easy detection at night
- Recommended for use with up to 24 volt transformers
- Available as a complete set with mounting hardware

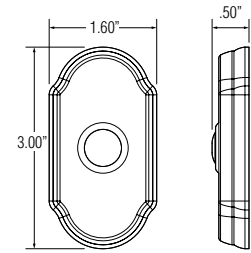

BR7004

Observascope



- 9BR7004-001** Venetian Bronze 112
- 9BR7004-002** Satin Nickel 150
- 9BR7004-003** Polished Chrome 260
- 9BR7004-004** Polished Brass 003

\$18.00

- Brass construction
- Provides one-way 170 degree angle visitor identification before entry
- Adjusts for use on 1.38" to 2.16" thick doors
- Bore hole diameter: 9/16"
- UL certified

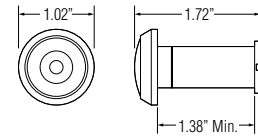

BR7012

Edge Pull



- 9BR7012-001** Venetian Bronze 112
- 9BR7012-002** Satin Nickel 150
- 9BR7012-003** Polished Chrome 260
- 9BR7012-004** Polished Brass 003
- 9BR7012-005** Matte Antique Nickel 152
- 9BR7012-006** Matte Brass & Black 049

\$17.00

- Brass construction
- Ideal for use on 1" or thicker doors
- Curved finger pull provides easy installation and use
- 1.32" pull projection

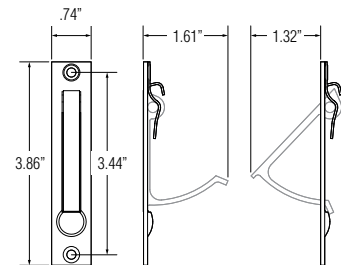

BR7018

Ball Catch



- 9BR7018-001** Venetian Bronze 112
- 9BR7018-002** Satin Nickel 150
- 9BR7018-003** Polished Chrome 260
- 9BR7018-004** Polished Brass 003
- 9BR7018-005** Matte Antique Nickel 152
- 9BR7018-006** Matte Brass & Black 049

\$20.00

- For use on louvered, bi-folding, accordion, closet and light to medium service doors
- Ball adjusts for door gap and latch tension
- Brass construction with steel ball
- Available as a complete set with mounting hardware

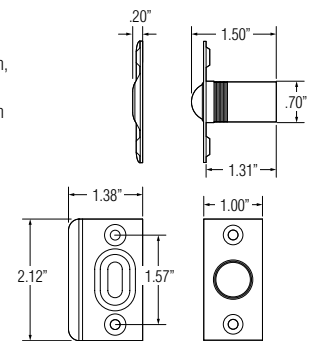

BR7020

Flush Bolt



- 9BR7020-001** Venetian Bronze 112
- 9BR7020-002** Satin Nickel 150
- 9BR7020-003** Polished Chrome 260
- 9BR7020-004** Polished Brass 003
- 9BR7020-005** Matte Antique Nickel 152
- 9BR7020-006** Matte Brass & Black 049

\$15.50

- Solid brass construction
- Features .94" extension bolt throw
- Smooth working action for easy operation
- Ideal for securing the inactive leaf of double doors
- Available as a complete set with strike, mounting hardware and installation instructions

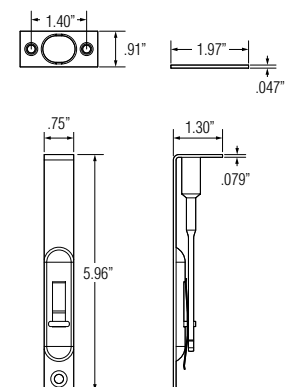

DOOR ACCESSORIES

Item	Part Number	List Price	Specifications	Dimensions
BR7021 Surface Bolt 6"	9BR7021-001 Venetian Bronze 112	\$29.50	<ul style="list-style-type: none"> • Solid brass construction • Ideal for securing doors, casement windows, cabinets and drawers • Furnished with both universal and mortise strikes • Solid brass mounting screws are concealed • Features .69" extension bolt throw and .67" knob projection from door 	
	9BR7021-002 Satin Nickel 150			
	9BR7021-003 Polished Chrome 260			
	9BR7021-004 Polished Brass 003			
	9BR7021-005 Matte Antique Nickel 152			
	9BR7021-006 Matte Brass & Black 049			
BR7022 Surface Bolt 4"	9BR7022-001 Venetian Bronze 112	\$26.50	<ul style="list-style-type: none"> • Solid brass mounting screws are concealed • Features .69" extension bolt throw and .67" knob projection from door 	
	9BR7022-002 Satin Nickel 150			
	9BR7022-003 Polished Chrome 260			
	9BR7022-004 Polished Brass 003			
	9BR7022-005 Matte Antique Nickel 152			
	9BR7022-006 Matte Brass & Black 049			

	A	B
Surface Bolt 6"	6"	5.25"
Surface Bolt 4"	4"	3.27"

WINDOW HARDWARE











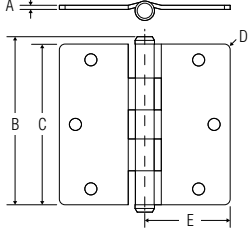

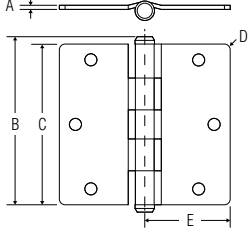
BR7013 Flush Pull	9BR7013-001 Venetian Bronze 112	\$19.00	<ul style="list-style-type: none"> • Brass construction • For use on large or heavy sliding doors and panels • Available as a complete set with mounting hardware and installation instructions 	
	9BR7013-002 Satin Nickel 150			
	9BR7013-003 Polished Chrome 260			
	9BR7013-004 Polished Brass 003			
	9BR7013-005 Matte Antique Nickel 152			
	9BR7013-006 Matte Brass & Black 049			

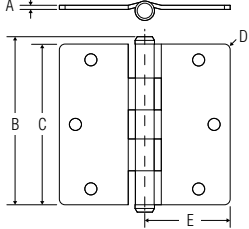
BR7014 Sash Lock	9BR7014-001 Venetian Bronze 112	\$19.00	<ul style="list-style-type: none"> • Solid brass construction • Secures and helps prevent air movement around double hung windows • Available as a complete set with mounting hardware 	
	9BR7014-002 Satin Nickel 150			
	9BR7014-003 Polished Chrome 260			
	9BR7014-004 Polished Brass 003			
	9BR7014-005 Matte Antique Nickel 152			
	9BR7014-006 Matte Brass & Black 049			

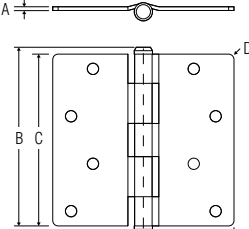
BR7019 Sash Lift	9BR7019-001 Venetian Bronze 112	\$18.00	<ul style="list-style-type: none"> • Solid brass construction • Ideal for use on double hung windows • Can also function as a door, cabinet or drawer pull • Projection: .97" • Includes mounting hardware 	
	9BR7019-002 Satin Nickel 150			
	9BR7019-003 Polished Chrome 260			
	9BR7019-004 Polished Brass 003			
	9BR7019-005 Matte Antique Nickel 152			
	9BR7019-006 Matte Brass & Black 049			

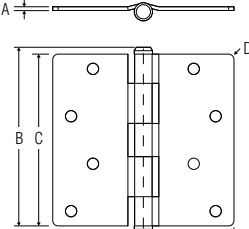
Item	Part Number	List Price	Specifications	Dimensions
DOOR STOPS				
BR7005 Rigid Door Stop 3" 	9BR7005-001 Venetian Bronze 112	\$14.00	<ul style="list-style-type: none"> • Brass construction • Heavy design helps prevent damage to walls • Pre-installed stud and slotted tip for easy installation 	
	9BR7005-002 Satin Nickel 150			
	9BR7005-003 Polished Chrome 260			
	9BR7005-004 Polished Brass 003			
	9BR7005-005 Matte Antique Nickel 152			
	9BR7005-006 Matte Brass & Black 049			
BR7006 Wall Bumper 1" (Convex) 	9BR7006-001 Venetian Bronze 112	\$14.00	<ul style="list-style-type: none"> • Brass collar • Convex surface with durable rubber bumper for long operating life • Includes mounting hardware and installation instructions 	
	9BR7006-002 Satin Nickel 150			
	9BR7006-003 Polished Chrome 260			
	9BR7006-004 Polished Brass 003			
	9BR7006-005 Matte Antique Nickel 152			
	9BR7006-006 Matte Brass & Black 049			
BR7029 Wall Bumper 2.4" (Convex) 	9BR7029-001 Venetian Bronze 112	\$14.00	<ul style="list-style-type: none"> • Brass collar • Convex surface with durable rubber bumper for long operating life • Includes mounting hardware and installation instructions 	
	9BR7029-002 Satin Nickel 150			
	9BR7029-003 Polished Chrome 260			
	9BR7029-004 Polished Brass 003			
	9BR7029-005 Matte Antique Nickel 152			
	9BR7029-006 Matte Brass & Black 049			
BR7007 Wall Bumper 2.4" (Concave) 	9BR7007-001 Venetian Bronze 112	\$14.00	<ul style="list-style-type: none"> • Brass collar • Concave surface with durable rubber bumper for long operating life • Includes mounting hardware and installation instructions 	
	9BR7007-002 Satin Nickel 150			
	9BR7007-003 Polished Chrome 260			
	9BR7007-004 Polished Brass 003			
	9BR7007-005 Matte Antique Nickel 152			
	9BR7007-006 Matte Brass & Black 049			
BR7008 Floor Bumper .38" 	9BR7008-001 Venetian Bronze 112	\$14.50	<ul style="list-style-type: none"> • Solid brass shell • Stops door and prevents damage to wall and doors • Positive stopping action provided by non-marring bumper • Designed for undercut doors or doors without threshold • Includes installation instructions and plastic anchor for concrete floor installation 	
	9BR7008-002 Satin Nickel 150			
	9BR7008-003 Polished Chrome 260			
	9BR7008-004 Polished Brass 003			
	9BR7008-005 Matte Antique Nickel 152			
	9BR7008-006 Matte Brass & Black 049			
BR7009 Floor Bumper .13" 	9BR7009-001 Venetian Bronze 112	\$14.50	<ul style="list-style-type: none"> • Solid brass shell • Stops door and prevents damage to wall and doors • Positive stopping action provided by non-marring bumper • Designed for undercut doors or doors without threshold • Includes installation instructions and plastic anchor for concrete floor installation 	
	9BR7009-002 Satin Nickel 150			
	9BR7009-003 Polished Chrome 260			
	9BR7009-004 Polished Brass 003			
	9BR7009-005 Matte Antique Nickel 152			
	9BR7009-006 Matte Brass & Black 049			

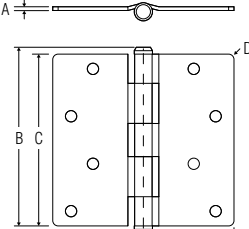
	A	B	C
Floor Bumper .38"	1.77"	1.24"	1.12"
Floor Bumper .13"	1.77"	1.09"	1.12"

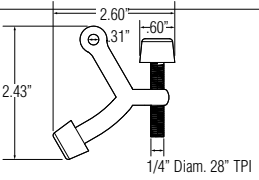
Item	Part Number	List Price	Specifications	Dimensions																				
HINGES																								
BR7023 3.5" 1/4" Radius 	9BR7023-001 Venetian Bronze 112	\$16.50	<ul style="list-style-type: none"> Solid brass construction designed for residential door applications Five knuckle, friction fit design with brass headed pin Non-rising pin with hole in bottom tip for easy removal Available as a complete set with mounting hardware Ordered and packed one (1) hinge per box Hinges ship dry to prevent chemical contamination on doors or wood jambs before finishing 	<div style="border: 1px solid black; padding: 5px; margin-bottom: 10px;"> Care & Maintenance <ul style="list-style-type: none"> Recommended to lubricate hinge pin with heavy bearing grease To lubricate, extract pin and wipe or dip with grease. Reinsert pin. Grease will work into load bearing surface. Wipe excess grease and dirt from hinge </div>  <table border="1" style="margin-top: 10px;"> <thead> <tr> <th>A</th> <th>B</th> <th>C</th> <th>D</th> <th>E</th> </tr> </thead> <tbody> <tr> <td>.08"</td> <td>3.82"</td> <td>3.5"</td> <td>.25"</td> <td>1.86"</td> </tr> <tr> <td>.08"</td> <td>3.82"</td> <td>3.5"</td> <td>.625"</td> <td>1.86"</td> </tr> <tr> <td>.08"</td> <td>3.83"</td> <td>3.5"</td> <td>N/A</td> <td>1.86"</td> </tr> </tbody> </table>	A	B	C	D	E	.08"	3.82"	3.5"	.25"	1.86"	.08"	3.82"	3.5"	.625"	1.86"	.08"	3.83"	3.5"	N/A	1.86"
	A				B	C	D	E																
	.08"				3.82"	3.5"	.25"	1.86"																
	.08"				3.82"	3.5"	.625"	1.86"																
	.08"				3.83"	3.5"	N/A	1.86"																
	9BR7023-002 Satin Nickel 150																							
	9BR7023-003 Polished Chrome 260																							
	9BR7023-004 Polished Brass 003																							
	9BR7023-005 Matte Antique Nickel 152																							
	9BR7023-006 Matte Brass & Black 049																							
9BR7023-010 Satin Black 190																								
BR7024 3.5" 5/8" Radius 	9BR7024-001 Venetian Bronze 112	\$16.50	<ul style="list-style-type: none"> Solid brass construction designed for residential door applications Five knuckle, friction fit design with brass headed pin Non-rising pin with hole in bottom tip for easy removal Available as a complete set with mounting hardware Ordered and packed one (1) hinge per box Hinges ship dry to prevent chemical contamination on doors or wood jambs before finishing 	<div style="border: 1px solid black; padding: 5px; margin-bottom: 10px;"> Care & Maintenance <ul style="list-style-type: none"> Recommended to lubricate hinge pin with heavy bearing grease To lubricate, extract pin and wipe or dip with grease. Reinsert pin. Grease will work into load bearing surface. Wipe excess grease and dirt from hinge </div>  <table border="1" style="margin-top: 10px;"> <thead> <tr> <th>A</th> <th>B</th> <th>C</th> <th>D</th> <th>E</th> </tr> </thead> <tbody> <tr> <td>.08"</td> <td>3.82"</td> <td>3.5"</td> <td>.25"</td> <td>1.86"</td> </tr> <tr> <td>.08"</td> <td>3.82"</td> <td>3.5"</td> <td>.625"</td> <td>1.86"</td> </tr> <tr> <td>.08"</td> <td>3.83"</td> <td>3.5"</td> <td>N/A</td> <td>1.86"</td> </tr> </tbody> </table>	A	B	C	D	E	.08"	3.82"	3.5"	.25"	1.86"	.08"	3.82"	3.5"	.625"	1.86"	.08"	3.83"	3.5"	N/A	1.86"
	A				B	C	D	E																
	.08"				3.82"	3.5"	.25"	1.86"																
	.08"				3.82"	3.5"	.625"	1.86"																
	.08"				3.83"	3.5"	N/A	1.86"																
	9BR7024-002 Satin Nickel 150																							
	9BR7024-003 Polished Chrome 260																							
	9BR7024-004 Polished Brass 003																							
	9BR7024-005 Matte Antique Nickel 152																							
	9BR7024-006 Matte Brass & Black 049																							
9BR7024-010 Satin Black 190																								
BR7025 3.5" Square 	9BR7025-001 Venetian Bronze 112	\$16.50	<ul style="list-style-type: none"> Solid brass construction designed for residential door applications Five knuckle, friction fit design with brass headed pin Non-rising pin with hole in bottom tip for easy removal Available as a complete set with mounting hardware Ordered and packed one (1) hinge per box Hinges ship dry to prevent chemical contamination on doors or wood jambs before finishing 	<div style="border: 1px solid black; padding: 5px; margin-bottom: 10px;"> Care & Maintenance <ul style="list-style-type: none"> Recommended to lubricate hinge pin with heavy bearing grease To lubricate, extract pin and wipe or dip with grease. Reinsert pin. Grease will work into load bearing surface. Wipe excess grease and dirt from hinge </div>  <table border="1" style="margin-top: 10px;"> <thead> <tr> <th>A</th> <th>B</th> <th>C</th> <th>D</th> <th>E</th> </tr> </thead> <tbody> <tr> <td>.08"</td> <td>3.82"</td> <td>3.5"</td> <td>.25"</td> <td>1.86"</td> </tr> <tr> <td>.08"</td> <td>3.82"</td> <td>3.5"</td> <td>.625"</td> <td>1.86"</td> </tr> <tr> <td>.08"</td> <td>3.83"</td> <td>3.5"</td> <td>N/A</td> <td>1.86"</td> </tr> </tbody> </table>	A	B	C	D	E	.08"	3.82"	3.5"	.25"	1.86"	.08"	3.82"	3.5"	.625"	1.86"	.08"	3.83"	3.5"	N/A	1.86"
	A				B	C	D	E																
	.08"				3.82"	3.5"	.25"	1.86"																
	.08"				3.82"	3.5"	.625"	1.86"																
	.08"				3.83"	3.5"	N/A	1.86"																
	9BR7025-002 Satin Nickel 150																							
	9BR7025-003 Polished Chrome 260																							
	9BR7025-004 Polished Brass 003																							
	9BR7025-005 Matte Antique Nickel 152																							
	9BR7025-006 Matte Brass & Black 049																							
9BR7025-010 Satin Black 190																								
BR7026 4" 1/4" Radius 	9BR7026-001 Venetian Bronze 112	\$18.00	<ul style="list-style-type: none"> Solid brass construction designed for residential door applications Five knuckle, friction fit design with brass headed pin Non-rising pin with hole in bottom tip for easy removal Available as a complete set with mounting hardware Ordered and packed one (1) hinge per box Hinges ship dry to prevent chemical contamination on doors or wood jambs before finishing 	<div style="border: 1px solid black; padding: 5px; margin-bottom: 10px;"> Care & Maintenance <ul style="list-style-type: none"> Recommended to lubricate hinge pin with heavy bearing grease To lubricate, extract pin and wipe or dip with grease. Reinsert pin. Grease will work into load bearing surface. Wipe excess grease and dirt from hinge </div>  <table border="1" style="margin-top: 10px;"> <thead> <tr> <th>A</th> <th>B</th> <th>C</th> <th>D</th> <th>E</th> </tr> </thead> <tbody> <tr> <td>.09"</td> <td>4.32"</td> <td>4"</td> <td>.25"</td> <td>2.11"</td> </tr> <tr> <td>.09"</td> <td>4.32"</td> <td>4"</td> <td>.625"</td> <td>2.11"</td> </tr> <tr> <td>.09"</td> <td>4.32"</td> <td>4"</td> <td>N/A</td> <td>2.11"</td> </tr> </tbody> </table>	A	B	C	D	E	.09"	4.32"	4"	.25"	2.11"	.09"	4.32"	4"	.625"	2.11"	.09"	4.32"	4"	N/A	2.11"
	A				B	C	D	E																
	.09"				4.32"	4"	.25"	2.11"																
	.09"				4.32"	4"	.625"	2.11"																
	.09"				4.32"	4"	N/A	2.11"																
	9BR7026-002 Satin Nickel 150																							
	9BR7026-003 Polished Chrome 260																							
	9BR7026-004 Polished Brass 003																							
	9BR7026-005 Matte Antique Nickel 152																							
	9BR7026-006 Matte Brass & Black 049																							
9BR7026-010 Satin Black 190																								
BR7027 4" 5/8" Radius 	9BR7027-001 Venetian Bronze 112	\$18.00	<ul style="list-style-type: none"> Solid brass construction designed for residential door applications Five knuckle, friction fit design with brass headed pin Non-rising pin with hole in bottom tip for easy removal Available as a complete set with mounting hardware Ordered and packed one (1) hinge per box Hinges ship dry to prevent chemical contamination on doors or wood jambs before finishing 	<div style="border: 1px solid black; padding: 5px; margin-bottom: 10px;"> Care & Maintenance <ul style="list-style-type: none"> Recommended to lubricate hinge pin with heavy bearing grease To lubricate, extract pin and wipe or dip with grease. Reinsert pin. Grease will work into load bearing surface. Wipe excess grease and dirt from hinge </div>  <table border="1" style="margin-top: 10px;"> <thead> <tr> <th>A</th> <th>B</th> <th>C</th> <th>D</th> <th>E</th> </tr> </thead> <tbody> <tr> <td>.09"</td> <td>4.32"</td> <td>4"</td> <td>.25"</td> <td>2.11"</td> </tr> <tr> <td>.09"</td> <td>4.32"</td> <td>4"</td> <td>.625"</td> <td>2.11"</td> </tr> <tr> <td>.09"</td> <td>4.32"</td> <td>4"</td> <td>N/A</td> <td>2.11"</td> </tr> </tbody> </table>	A	B	C	D	E	.09"	4.32"	4"	.25"	2.11"	.09"	4.32"	4"	.625"	2.11"	.09"	4.32"	4"	N/A	2.11"
	A				B	C	D	E																
	.09"				4.32"	4"	.25"	2.11"																
	.09"				4.32"	4"	.625"	2.11"																
	.09"				4.32"	4"	N/A	2.11"																
	9BR7027-002 Satin Nickel 150																							
	9BR7027-003 Polished Chrome 260																							
	9BR7027-004 Polished Brass 003																							
	9BR7027-005 Matte Antique Nickel 152																							
	9BR7027-006 Matte Brass & Black 049																							
9BR7027-010 Satin Black 190																								
BR7028 4" Square 	9BR7028-001 Venetian Bronze 112	\$18.00	<ul style="list-style-type: none"> Solid brass construction designed for residential door applications Five knuckle, friction fit design with brass headed pin Non-rising pin with hole in bottom tip for easy removal Available as a complete set with mounting hardware Ordered and packed one (1) hinge per box Hinges ship dry to prevent chemical contamination on doors or wood jambs before finishing 	<div style="border: 1px solid black; padding: 5px; margin-bottom: 10px;"> Care & Maintenance <ul style="list-style-type: none"> Recommended to lubricate hinge pin with heavy bearing grease To lubricate, extract pin and wipe or dip with grease. Reinsert pin. Grease will work into load bearing surface. Wipe excess grease and dirt from hinge </div>  <table border="1" style="margin-top: 10px;"> <thead> <tr> <th>A</th> <th>B</th> <th>C</th> <th>D</th> <th>E</th> </tr> </thead> <tbody> <tr> <td>.09"</td> <td>4.32"</td> <td>4"</td> <td>.25"</td> <td>2.11"</td> </tr> <tr> <td>.09"</td> <td>4.32"</td> <td>4"</td> <td>.625"</td> <td>2.11"</td> </tr> <tr> <td>.09"</td> <td>4.32"</td> <td>4"</td> <td>N/A</td> <td>2.11"</td> </tr> </tbody> </table>	A	B	C	D	E	.09"	4.32"	4"	.25"	2.11"	.09"	4.32"	4"	.625"	2.11"	.09"	4.32"	4"	N/A	2.11"
	A				B	C	D	E																
	.09"				4.32"	4"	.25"	2.11"																
	.09"				4.32"	4"	.625"	2.11"																
	.09"				4.32"	4"	N/A	2.11"																
	9BR7028-002 Satin Nickel 150																							
	9BR7028-003 Polished Chrome 260																							
	9BR7028-004 Polished Brass 003																							
	9BR7028-005 Matte Antique Nickel 152																							
	9BR7028-006 Matte Brass & Black 049																							
9BR7028-010 Satin Black 190																								
BR7011 Hinge Pin Door Stop 	9BR7011-001 Venetian Bronze 112	\$10.00	<ul style="list-style-type: none"> Solid brass construction Adjustable to stop door at any angle with rubber pad making contact with door Hinge pin door stop can be used with Reserve hinges only. Not compatible with Baldwin Estate hinges. 																					
	9BR7011-002 Satin Nickel 150																							
	9BR7011-003 Polished Chrome 260																							
	9BR7011-004 Polished Brass 003																							
	9BR7011-005 Matte Antique Nickel 152																							
	9BR7011-006 Matte Brass & Black 049																							